

# USER MANUAL

---

Ultrasound therapy

# Powersonic



I.A.C.E.R. Srl

Via Enzo Ferrari 2 - 30037 Scorzè (VE) - Italia/Italy - Tel: (+39) 041/5401356 - Email: iacer@iacer.it  
PEC: iacer@pec.it - Web: www.itechmedicaldivision.com - Cod. Fisc./PIVA/VAT N.: IT00185480274  
R.E.A.: VE N. 120250 - M. VE001767 - Codice SDI/SDI Code: SUBM70N - Cap. Soc.: € 1.000.000,00 Iv.





<b>TABLE OF CONTENTS</b>	<b>I</b>
<b>TECHNICAL INFORMATION</b>	<b>1</b>
MANUFACTURER	1
DECLARATION OF CONFORMITY	1
CLASSIFICATIONS	2
INTENDED PURPOSE AND SCOPE OF USE	2
TECHNICAL SPECIFICATIONS	3
DEVICE DESCRIPTION AND CONTROLS	4
LABELLING	5
<i>Pack contents</i>	7
<b>HOW TO USE</b>	<b>8</b>
INTRODUCTION TO THE TECHNOLOGY	8
CONTRAINDICATIONS	9
WARNINGS	9
DEVICE USE	11
<i>Treatments</i>	14
<b>LOOKING AFTER THE DEVICE</b>	<b>15</b>
MAINTENANCE	15
TROUBLESHOOTING	16
<i>Charging the battery</i>	17
<i>Replacing the Battery</i>	18
DISPOSAL INFORMATION	18
WARRANTY	19
<i>Support</i>	20
<i>Spare parts</i>	20
INTERFERENCE AND ELECTROMAGNETIC COMPATIBILITY TABLES	21



## Manufacturer

**I.A.C.E.R.S.r.l.**

Via Enzo Ferrari, 2 • 30037 Scorzè (VE)

Tel.: +39 041.5401356 • Fax: +39 041.5402684

IACER S.r.l. is an Italian manufacturer of medical devices (CE certificate no. 0068/QCO-DM/235-2020 issued by the Notified Body no. 0068 MTIC InterCert S.r.l.).

## Declaration of conformity

**I.A.C.E.R.S.r.l.**

Via Enzo Ferrari, 2 – 30037 Scorzè (Ve), Italy

declares under its own responsibility that the product

**POWERSONIC**

UMDNS code: **11248**

is designed and built in compliance with Directive 93/42/EEC concerning medical devices (implemented in Italy with Legislative Decree 46/97), as amended by Directive 2007/47/EC (Legislative Decree 37/2010) and subsequent amendments/additions.

The device is classified class IIa, according to Annex IX, rule 9 of Directive 93/42/EEC (and subsequent amendments/additions) and is marked



The conformity of the product in question with the Directive 93/42/EEC has been verified and certified by the Notified Body:

**0068 - MTIC InterCert S.r.l.**

**Via G. Leopardi 14, Milan (MI) 20123, Italy**

CertificateNo.:0068/QCO-DM/235-2020

according to the certification process provided for in Directive 93/42/EEC, Annex II (excluding point 4).

  
MASSIMO MARCON

Scorzè, 31/01/2022

*Place, date*

*Legal Representative*

## Classifications

The POWERSONIC device assumes the following classifications:

- class IIa device (Directive 93/42/EEC, annex IX, rule 9 and subsequent amendments/additions);
- class II with type BF applied part (Classif. EN 60601-1);
- device with IP22 protection degree against the penetration of solids and liquids into the machine body. IPX7 protection degree for the treatment head. DEVICE NOT SUITABLE FOR USE IN IMMERSION.
- equipment and accessories not subject to sterilisation;
- device not suitable for use in the presence of a flammable anaesthetic mixture with air or with oxygen or with nitrous oxide;
- device intended for continuous operation;
- device not suitable for external use.

## Intended purpose and scope of use

Intended use:                      Therapeutic  
Scope of use:                     Outpatient and domestic

The POWERSONIC device for ultrasound therapy is ideal for the treatment of conditions and diseases affecting the musculoskeletal system, in order to guarantee an analgesic and anti-inflammatory effect in various problems. This type of device is designed for the following applications:

- Myofascial pain
- Muscle pain
- Carpal tunnel syndrome
- Venous and pressure ulcers
- Lumbar pain
- Arthrosis
- Epicondylitis
- Epicondylitis (Golfer's elbow)
- Tendinitis
- Cubital tunnel syndrome
- Lumbar stenosis
- Sciatica

The user of the device can be either the patient or a professional operator.

The patient population intended for ultrasound treatment using the POWERSONIC device includes patients of both sexes, men and women, of legal age (unless otherwise indicated by doctors). For further details, please refer to the *Contraindications section*.

## Technical specifications

Feature	Specification
Power Supply	IN:100-240V~, 50/60 Hz, 0.6-0.2 A OUT:15V ---1.2A
Battery	Ni-MH AAA850mAh 4.8 V
External dimensions (Length x Width x Height)	204x63x58mm
Ingress protection rating IP	IP22 machine body IPX7 head
Insulation (EN 60601-1)	II
Applied parts (EN 60601-1)	BF
Part applied to the patient	Aluminium head of the device
Operation	Continuous
Wave form	Pulsed, continuous
Carrier frequency of use	1MHz $\pm$ 10%
Modulation frequency	100Hz $\pm$ 10%
Duty cycle	5%, 50%, 100% (mains powered) 5%, 50%, 100% (battery powered)
Power	Can be set in 3 steps L (low) - M (medium) - H (high)
Maximum power density	1.6W/cm <sup>2</sup> (mains powered) 0.8W/cm <sup>2</sup> (battery powered)
Maximum output power	6.4W (mains powered)

Feature	Specification	
	3.2W (battery powered)	
RBN (max)	5.0	
Head surface	5 cm <sup>2</sup>	
Actual radiant area	4 cm <sup>2</sup> ± 20%	
Beam type	Collimated	
Head material	Aluminium	
Treatment time	5, 10, 15 minutes	
Usage conditions	Ambient temperature	From +5° to +40°C
	Relative humidity	From 15% to 93%
	Atmospheric pressure	From 700 to 1060hPa
Transport and storage conditions	Ambient temperature	From +5° to +40°C
	Relative humidity	From 15% to 93%
	Atmospheric pressure	From 700 to 1060hPa

Useful life of the device and its accessories: 3 years.

### Device description and controls

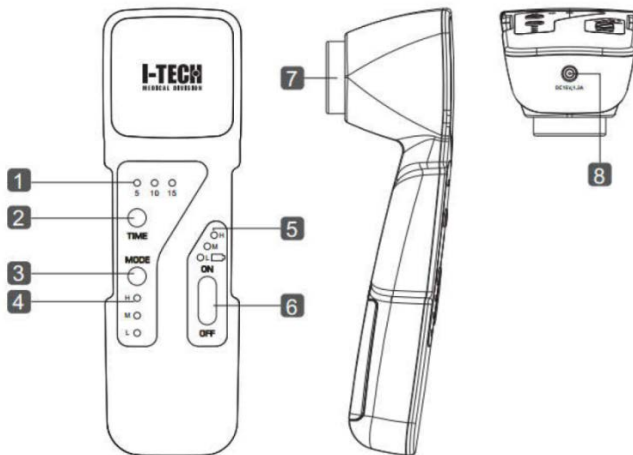

- (1) Therapy time indicator
- (2) Time button



- (3) Power adjustment button
- (4) Treatment power indicator
- (5) Battery indicator
- (6) Device ON/OFF button
- (7) Emitting head
- (8) Power supply connector

## Labelling

**Modello: Powersonic**

**Alimentazione**

Ingresso: 100-240V~, 50/60 Hz, 0.6-0.2A

Output: 15V $\overline{\text{---}}$ 1.2A

Batteria: Ni-MH AAA850mAh 4.8V

**Ultrasuoni**

Frequenza di lavoro: 1 MHz  $\pm$  10%

Ciclo di lavoro:

5%, 50%, 100% (alimentato a rete)

5%, 50%, 100% (alimentato a batteria)

Potenza di uscita (max):

6.4W (alimentato a rete)

3.2W (alimentato a batteria)

RBN (max): 5.0 Area eff.: 4.0 cm<sup>2</sup>  $\pm$  20%

Forma d'onda: pulsata, continua

Tipo di fascio: collimato

Frequenza di modulazione: 100 Hz  $\pm$  10%

Durata d'impulso: 0.5ms, 5ms





**IPX7:** solo per la testa del dispositivo





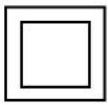

I.A.C.E.R. Srl, via Enzo Ferrari 2,  
30037 Scorzè (VE), Italy

SN XXXXXX XXXX-XX

## Gel labelling



Symbol	Description
	Follow the "instructions for use"
	WEEE Directive
	Type BF applied part
	Class II device

Symbol	Description
	In compliance with Directive 93/42/EEC Medical Devices (and subsequent amendments Dir.(2007/47/EC)
	Serial number
	Allowed temperatures (storage temperatures, on packaging)
	Relative humidity (storage relative humidity, on packaging)
	Date of manufacture (YYYY-MM)
	Power supply
	Warning, see the documents accompanying the product
<b>IP22</b>	Device protected against the penetration of solids (with diameter $d \geq 12.5mm$ ) and against the fall of vertical drops of water when the device is held at $15^\circ$ from the normal operating position.

### Pack contents

The POWERSONIC pack contains:

- 1 POWERSONIC device;
- 1 medical power supply;
- 1 battery charger;
- 1 gel for ultrasound;
- 1 carry bag;
- 1 user manual.

## Introduction to the technology

Ultrasound therapy represents a method that is based on the transfer of energy into the tissues which results in thermal and non-thermal biological effects.

This treatment is based on the contact between the head of the device and the tissues being treated. The optimal coupling of these two surfaces is ensured by the use of a water-based ultrasound gel. Through the contact described the transmission of general mechanical waves from the piezoelectric present inside the head of the device takes place. In order for there to be maximum transmission of energy from one medium to another, the impedance of the two must be the same. Obviously in the case of the human body, such condition hardly occurs. The greater the impedance difference between the two media, the greater the reflection and consequently the smaller the amount of energy that will be transferred. The impedance difference is greatest with aluminium-air interface, which is the first that ultrasound waves would have to overcome to reach the body. To reduce this difference, a coupling substance must be used. If there is a small amount of air between the transducer and the skin, the proportion of ultrasound waves that would be reflected would reach 99.998%, i.e. there would be no transmission.

In addition to the phenomenon of reflection, if the wave does not hit the separation surface between the media at 90°, refraction occurs. In practice, the direction of the ultrasound beam through the second medium will be angled. The critical angle for ultrasound waves at the skin surface appears to be 15°. If the device head is oriented at a 15° angle to the surface, most of the beam will propagate through the epidermal tissues parallel to the skin rather than perpendicular to the tissues.

The absorption of the energy released by the ultrasound waves follows an exponential trend, in fact much more energy is absorbed in superficial tissues rather than in deep ones.

Precisely due to the trend of absorption, theoretically there is no point where all the energy is absorbed, but there is certainly a point where these levels are not sufficient to produce a therapeutic effect.

Generally tissues with the highest protein content will absorb more, unlike tissues with high water and low protein content, which will absorb a minimal amount of energy (blood and fat, for example).

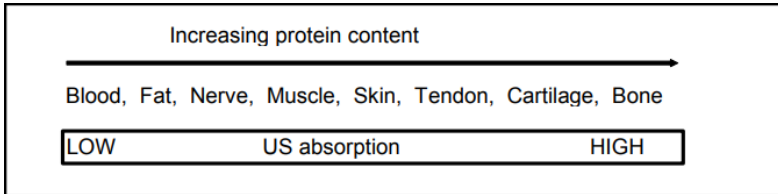

## Contraindications

It is strictly prohibited to use POWERSONIC in patients with severe arrhythmias or with pacemakers, with heart disease and severe cardiovascular problems, who suffer from epilepsy, with ongoing phlebitis, thrombophlebitis, in feverish states, tuberculosis, malignant tumours and neoplasms, local infections, metal implants (possible after consulting a doctor), venous thrombosis, severe osteoporosis, arteriopathies (except medical prescriptions).

**No side effects were found when using POWERSONIC.**

## Warnings

### **It is recommended:**

- to use the device keeping the applicator at least 3 metres away from televisions, monitors, mobile phones or any other electronic equipment even if the device does not generate or receive any electromagnetic interference from other equipment;
- to avoid use of the device by people who are not properly trained and who have not read this manual;
- during therapy, the user is advised not to wear metal objects;
- to use ONLY the accessories supplied by the manufacturer.

**It is forbidden:**

- to use the device in the presence of equipment for monitoring the patient's vital functions, equipment for electrosurgery or for short wave or microwave therapy or other devices that send electrical impulses to the body and in general in combination with other medical devices;
- for the device to be used by people of unsound mind, suffering from sensory processing disorders, temporarily unfit unless assisted by qualified personnel;
- to use with patients under the age of 18;
- to use the device if you find any damage or signs of deterioration to it or to the accessories and/or cables: contact the retailer or the manufacturer as indicated in the *Support* paragraph. Check the condition of the device before each use;
- to use the device near flammable substances, gases, explosives, in environments with high oxygen concentrations, in the presence of aerosols or in very humid environments (do not use in the bathroom or while showering/bathing);
- to use the device while driving vehicles or while operating and controlling equipment/machinery;
- to use the device in hyposensitive areas, on carotid sinuses, genitals, near the uterus and abdomen, in areas of the body where there are glands. Also avoid using the device on the neck and mouth. Finally, avoid treatment with direct exposure of the eye to the ultrasonic beam;
- ***keep the treatment head fixed in one place during therapy;***
- to use sharp objects on the device head.

**Warning:**

- pay attention to the use of connection cables in the presence of children/young people: potential strangulation hazard;
- do not confuse the connection cables with headphone cables or other devices and do not connect the cables to other devices.
- The device is not intended for outdoor use.

The manufacturer is to be considered responsible for the safety, reliability and performance of the device provided that:

- any additions, modifications and/or repairs are carried out by authorised personnel;
- the electrical system of the environment in which POWERSONIC is installed complies with national laws;
- the device is used in strict compliance with the instructions given in this manual.

Should any foreign substances get into the device, contact the dealer or manufacturer immediately. Should the device fall, check that there are no cracks in the container or damage of any kind; if there are, contact your dealer or manufacturer.

In the event of any change in performance during treatment, stop treatment immediately and contact your dealer or manufacturer immediately.



Consult your doctor before using POWERSONIC with metallic osteosynthesis devices.

**CONSULT YOUR DOCTOR IF YOU HAVE ANY DOUBTS ABOUT USING THE DEVICE.**

## Device use

Clean and disinfect the ultrasound head with a disinfectant solution before and after use.

To use POWERSONIC:

1. connect the power supply to the device, if the device is not battery operated.
2. Before starting therapy, make sure to clean the treatment area with a 70% alcohol solution or mild soap. It is recommended to remove excessive hair in the treatment area.
3. Apply a good amount of ultrasound gel in the treatment area (**ONLY USE GEL WITH CE MARKING**). Gel is essential to ensure a correct coupling between the treatment area and the head and therefore the effectiveness of the therapy.

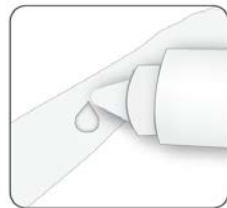

**WARNING: do not apply the gel directly on the head. The device may interpret this as skin-to-head contact and emit ultrasound energy, damaging the device.**

- Turn on the device by moving the switch to the **ON** position. The ultrasound intensity indicator will display L (Low, preset), whereas the battery level indicator will indicate the battery capacity: low (L-Low preset), medium (M-Medium) and high (H-High).
- Select the desired intensity by repeatedly pressing the **MODE** key. There are three levels of intensity selectable in order: low (preset L – Low), medium (M – Medium) and high (H – High).

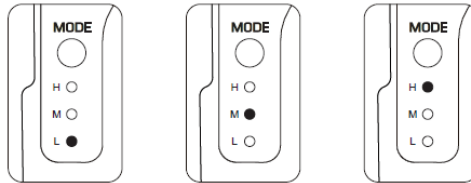

- Select the therapy time by repeatedly pressing the **TIME** key: the LEDs relating to the 5-10-15 minutes of therapy will light up in sequence, as shown in the figure. When in use, the chosen therapy time indicator will be constantly lit until the set time has elapsed.

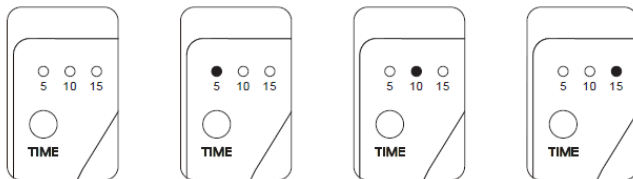

- Once the therapy time has been set and the head has been placed in contact with the skin, the treatment will begin: it is important to perform the therapy **by continuously and uniformly moving the head around the treatment area, with slow and circular movements**. The treated area should be twice the applicator diameter. If there is poor transmission of ultrasound energy, it is recommended to add more gel or reposition the ultrasound head.

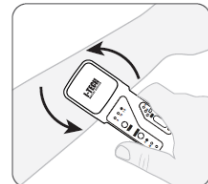





Head movement should not be too slow to avoid inducing heat; nor too fast to prevent bad contact which would reduce the effectiveness of the treatment.

8. At the end of the therapy all the indicator lights will turn off. Turn the switch to **OFF** and disconnect the device from the power supply (not needed if you are using the device with battery).
9. Clean any gel off the head before storing the device and its accessories in the bag provided. **Make sure there is no gel left on the head. DO NOT SUBMERGE IN WATER!**

**N.B.:** disconnect the cables before putting the device in the bag. If this is not done, the cables can be excessively bent near the connectors, which can damage the cables.



**WARNING:** to ensure patient safety, the device is equipped with a system that detects correct coupling between the ultrasound head and the patient's skin. **In the event of incorrect coupling or bad contact, the therapy time LED will start flashing and the ultrasound intensity will be reduced.** Once head/skin contact is restored, the intensity will automatically increase slowly, up to the previously set level.



**WARNING:** to ensure patient safety, the device is also equipped with a temperature regulation system. **If the head temperature exceeds 42°C, the device will end the treatment and the time indicator LED will flash twice;** it will not be possible to resume treatment until the head reaches a temperature below 40°C.

## Treatments

Below is the list of treatments suggested by the manufacturer:

Treatment	Intensity	Minutes
<b>Myofascial pain</b>	H - Power supply	5
<b>Muscle pain</b>	H - Power supply	5
<b>Carpal tunnel syndrome</b>	M - Power supply H - Battery	15
<b>Venous ulcers</b>	M - Battery	10
<b>Pressure ulcers</b>	M - Battery	10
<b>Lumbar pain</b>	H - Power supply	10
<b>Arthrosis</b>	M - Power supply H - Battery	5
<b>Epicondylitis</b>	H - Power supply	10
<b>Epicondylitis (Golfer's elbow)</b>	H - Power supply	10
<b>Tendinitis</b>	H - Power supply	10
<b>Cubital tunnel syndrome</b>	H - Power supply	5
<b>Lumbar stenosis</b>	H - Power supply	10
<b>Sciatica</b>	H - Power supply	10

You should always consult your doctor before using the Powersonic device.



### REMEMBER TO:

- keep the ultrasound head always in motion;
- use a good amount of gel to ensure contact;
- act evenly on the treated area.

## Maintenance

If used in accordance with the information reported herein, this device requires no particular routine maintenance operations.

It is advisable to carry out a functional check of the device at the Manufacturer every 24 months.

The manufacturer does not consider the POWERSONIC device to be repairable by personnel outside the company itself. Any such operation by personnel not authorised by the Manufacturer will be considered tampering with the device, thereby voiding the manufacturer's warranty and freeing it from liability for any hazards to which the operator or user may be subjected.

### **CLEANING**

It is advisable to switch off the POWERSONIC at the end of each therapy session, in addition to removing the power cable.

Use a soft dry cloth to remove any dust from the device. In case of hard-to-remove dirt, use a cloth soaked in water and alcohol.

The device does not require sterilisation.

### **Notes:**

- Never use solvents for cleaning. Cleaning agents can damage the device.
- Carry out routine maintenance, in particular:
  - inspect the body of the device for cracks or fissures, which may allow liquids to enter;
  - inspect the cables.

### **TRANSPORT AND STORAGE**

#### **Transport precautions**

There is no particular care to be taken during transport as POWERSONIC is a portable device. However, it is recommended to put POWERSONIC and its accessories in the bag provided after each use. Protect the device from intense heat, direct sunlight and liquids. Store the device in a cool and well ventilated environment.

Do not place heavy objects on top of the device.

### Storage precautions

The storage location should have the following characteristics:

During operation

ambient temperature	from +5 to + 40°C
relative humidity	from 15 to 93%
pressure	from 700 to 1060 hPa

In the bag provided

ambient temperature	from +5 to +40 °C
relative humidity	from 15 to 93%
pressure	from 700 to 1060 hPa

### Troubleshooting

Any type of work on POWERSONIC must only be carried out by the manufacturer or authorised dealer. In any case, before sending POWERSONIC to the manufacturer, it will be necessary to ascertain the exact nature of the POWERSONIC malfunction.

Check the following:

PROBLEM	POSSIBLE CAUSE	SOLUTION
The device does not turn on	Adapter contact error	Make sure the adapter is connected.
	The device does not work	Check the following contacts:
The LED indicators do not light up	The battery is damaged	<ul style="list-style-type: none"> <li>• All contacts are fine</li> <li>• All contacts are not broken</li> <li>• The battery is OK</li> </ul>
	Mains plug not inserted correctly in the power socket.	Check the operation of the power socket.
	Mains cable not correctly inserted in the connector of the device.	Insert the plug and cable correctly into the connector of the appliance.

PROBLEM	POSSIBLE CAUSE	SOLUTION
	Mains cable worn and broken.	Replace the mains cable.
	Switch not turned ON.	Check that you have turned the switch ON.
The power LED is working fine but there is no output	Time and intensity set incorrectly.	Check and reset the desired values.
Some controls do not work properly.	Defective buttons or keys.	Contact the manufacturer
	Electronic control circuit failure.	
The device works as normal, but there is a noticeable drop in the effectiveness of the treatment.	Possible head fault.	Contact the manufacturer
	Possible failure of the appliance's power generator circuit.	
All battery indicators flash	The battery is damaged	Change the battery
	There is no battery	

### Charging the battery

The device can be powered by the internal battery: when the battery level indicators are all off or the battery charge indicator is flashing to L (Low), it is necessary to charge the battery by connecting the adapter to the device.

When the device is charging: the battery indicator will flash from L-M-H in sequence. Once charging is complete, the battery charge indicator will light up as H (High).



**WARNING:** the battery life cycle depends on the charge/discharge cycles to which it is subjected and on the number of them.

Take the following precautions to increase battery life:

- Recharge the battery once a month, even when not using the device;
- Drain the battery as much as possible during use.

### Replacing the Battery

The battery must only be replaced by personnel authorised by the manufacturer and not by the user. In addition, the batteries are disposed of in accordance with current regulations (WEEE).

Therefore, for replacement, contact IACER s.r.l. support directly (*Support paragraph*).

### Disposal Information

POWERSONIC devices, in line with operating and safety requirements, have been designed and built to have a minimum negative impact on the environment, following the provisions of the European Directive 2012/19/EU relating to the disposal of waste electrical and electronic equipment.

The criteria followed are those of minimising the amount of waste, toxic materials, noise, unwanted radiation and energy consumption.

Careful research into optimising machine performance guarantees a significant reduction in consumption, in accordance with the concept of energy saving.



This symbol indicates that this product should not be disposed with other household waste.

Correct disposal of obsolete equipment, accessories and especially batteries helps to prevent possible negative consequences on human health and the environment.

The user must dispose of the equipment to be scrapped by taking it to the collection centre indicated for the subsequent recycling of electrical and electronic equipment.

For more detailed information on the disposal of obsolete equipment, contact your local council, waste disposal service or shop where you purchased the product.

## Warranty

POWERSONIC is covered by a 2 (two) year warranty, starting from the date of purchase, on the electronic parts, when used in accordance with the instructions provided in this manual. The parts subject to wear and tear are excluded from the warranty, unless there are obvious manufacturing defects. The warranty will lapse if: the device is modified in any way or operated by staff not authorised by the manufacturer or by the authorised dealer.

*As established by the Medical Device Directive 93/42/EEC, the manufacturer is obliged to trace at any time the equipment supplied to intervene promptly, if necessary, as a result of manufacturing defects.*

*The warranty conditions are those described in the following paragraph*  
Warranty conditions. *The warranty is provided by IACER.*

Should you need to return the goods then please pack the device and all the accessories so that it won't be damaged during transportation. In order to be entitled to the warranty assistance, the purchaser must enclose to the device a copy of the purchasing receipt, proving origin and purchasing date.

For more information on the warranty please contact the distributor or vendor, in order to check the norm and standard in force in your Country, or ultimately the manufacturer IACER Srl.

### Warranty terms and conditions

- 1) Any warranty claim must be accompanied by the receipt or invoice, that will be sent together with the goods to the manufacturer.
- 2) The warranty period is 2 years (two) and covers the electronic parts of the device. The warranty claim can be addressed to the dealer from which you have purchased the device or directly to the manufacturer.
- 3) The warranty only covers damage to the product that causes it to malfunction.
- 4) The warranty is understood to be the free repair or replacement of components recognised as faulty due to manufacturing or material defects, including labour.
- 5) The warranty does not apply in case of damage caused by negligence or use that does not comply with the instructions provided, damage caused by operations carried out by

unauthorised persons, damage due to accidental causes or negligence of the purchaser, with particular reference to external parts.

- 6) The warranty does not cover any damage caused by incorrect power supply to the device.
- 7) The parts subject to wear and tear once the device has been used are excluded from the warranty.
- 8) The warranty does not include transport costs that will be borne by the buyer in relation to the modes and times of transportation.
- 9) The warranty automatically expires after 2 years. In this case, any assistance operations will be performed by charging for the replaced parts, labour costs and transport costs according to the current rates.
- 10) Any disputes that may arise shall be settled exclusively before the court of Venice.

### **Support**

The manufacturer is the only point of contact for technical support regarding the device. For all technical support matters, please contact:

**I.A.C.E.R.S.r.l.**

Via Enzo Ferrari, 2 • 30037 Scorzè (VE)  
Tel.: +39 041.5401356 • Fax: +39 041.5402684

Technical documentation concerning repairable parts may be provided, but only with prior company authorisation and only after giving proper training to the maintenance personnel.

### **Spare parts**

Original spare parts for this device can be ordered at any time from the manufacturer. To order them contact:

**I.A.C.E.R.S.r.l.**

Via Enzo Ferrari, 2 • 30037 Scorzè (VE)  
Tel.: +39 041.5401356 • Fax: +39 041.5402684

Use only original spare parts supplied by the manufacturer; if non-original spare parts are used, the operation and safety of the product might be affected and the warranty will be null and void.



## Interference and electromagnetic compatibility tables

The POWERSONIC ultrasound therapy device is designed and built in compliance with the current TECHNICAL STANDARD on ELECTROMAGNETIC COMPATIBILITY EN 60601-1-2:2015, with the aim of providing reasonable protection against harmful interference in residential, civil and healthcare settings.

Based on its operating principle, the device does not generate significant radio frequency energy and has an adequate level of immunity to radiating electromagnetic fields. Under these conditions, harmful interference cannot occur to radioelectric communications and to the operation of electro-medical devices used for monitoring, diagnosis, therapy and surgery, to the operation of electronic office devices such as computers, printers, copiers, faxes, etc. and to any electrical or electronic appliance used in such environments, provided that they comply with the ELECTROMAGNETIC COMPATIBILITY directive.

In any case, to prevent any problem with interference, it is recommended to operate any therapy device at an appropriate distant from critical equipment for monitoring patients' vital functions and to use caution in therapeutic applications on patients with pacemakers. However, it is advisable to use the device keeping a distance of at least 3 metres from televisions, monitors, mobile phones or any other electronic equipment.

For more details consult the compatibility tables in Italian/English at the end of the manual.

POWERSONIC. All rights reserved. POWERSONIC and the logo  are the exclusive property of I.A.C.E.R.S.r.l. and are registered trademarks

**Issue: MNPG345-02 of 31/01/2022**

## TABELLE DI COMPATIBILITÀ ELETTROMAGNETICA – ELECTROMAGNETIC COMPATIBILITY TABLES

<b>Guida e dichiarazione del costruttore – EMISSIONI ELETTROMAGNETICHE – PER TUTTI GLI APPARECCHI ED I SISTEMI</b> <b><i>Guidance and manufacturer’s declaration – ELECTROMAGNETIC EMISSIONS – FOR ALL EQUIPMENT AND SYSTEMS</i></b>		
<p>Il POWERSONIC è previsto per funzionare nell’ambiente elettromagnetico sotto specificato. Il cliente o l’utente di POWERSONIC deve garantire che esso venga usato in tale ambiente.</p> <p><i>The POWERSONIC is intended for use in the electromagnetic environment specified below. The customer or the user of the POWERSONIC should assure that it is used in such an environment.</i></p>		
<b>Prova di emissione</b> <b><i>Emissions Test</i></b>	<b>Conformità</b> <b><i>Compliance</i></b>	<b>Ambiente elettromagnetico – Guida</b> <b><i>Electromagnetic environment - guidance</i></b>
Emissioni RF <i>RF emissions</i> CISPR 11	Gruppo 1 <i>Group 1</i>	<p>Il POWERSONIC utilizza energia RF solo per il suo funzionamento interno. Perciò le sue emissioni RF sono molto basse e verosimilmente non causano nessuna interferenza negli apparecchi elettronici vicini</p> <p><i>The POWERSONIC uses RF energy only for its internal function. Therefore, its RF emissions are very low and are not likely to cause any interference in nearby electronic equipment.</i></p>
Emissioni RF <i>RF emissions</i> CISPR 11	Classe B <i>Class B</i>	<p>Il POWERSONIC è adatto per l’uso in tutti i locali compresi quelli domestici e quelli collegati direttamente ad un’alimentazione di rete pubblica a bassa tensione che alimenta edifici usati per scopi domestici.</p> <p><i>The POWERSONIC is suitable for domestic establishment and in establishment directly connected to the public low-voltage power supply network that supplies buildings used for domestic purposes.</i></p>
Emissioni armoniche <i>Harmonics emissions</i> IEC 61000-3-2	Classe A <i>Class A</i>	
Emissioni di fluttuazioni di tensione/flicker <i>Voltage fluctuation/flicker emissions</i> IEC 61000-3-3	Conforme <i>Compliant</i>	

<b>Guida e dichiarazione del costruttore – IMMUNITÀ ELETTROMAGNETICA – PER TUTTI GLI APPARECCHI ED I SISTEMI</b> <b>Guidance and manufacturer's declaration – ELECTROMAGNETIC IMMUNITY – FOR ALL EQUIPMENT AND SYSTEMS</b>			
<p>Il POWERSONIC è previsto per funzionare nell'ambiente elettromagnetico sotto specificato. Il cliente o l'utilizzatore di POWERSONIC deve garantire che esso venga usato in tale ambiente.</p> <p><i>The POWERSONIC is intended for use in the electromagnetic environment specified below. The customer or the user of the device should assure that it is used in such an environment</i></p>			
<b>Prova di immunità</b> <b>Immunity test</b>	<b>Livello di prova</b> <b>Test level</b> <b>IEC 60601</b>	<b>Livello di conformità</b> <b>Compliance level</b>	<b>Ambiente elettromagnetico – Guida</b> <b>Electromagnetic environment - guide</b>
Scarica elettrostatica (ESD) <i>Electrostatic discharge (ESD)</i>  IEC 61000-4-2	$\pm 8\text{kV}$ a contatto / <i>in contact</i> $\pm 15\text{kV}$ in aria / <i>on air</i>	$\pm 8\text{kV}$ a contatto / <i>in contact</i> $\pm 15\text{kV}$ in aria / <i>on air</i>	I pavimenti devono essere in legno, calcestruzzo o in ceramica. Se i pavimenti sono ricoperti di materiale sintetico, l'umidità relativa dovrebbe essere almeno 30%. <i>Floors should be wood, concrete or ceramic tile. If floors are covered with synthetic material, the relative humidity should be at least 30%.</i>
Transitori/treni elettrici veloci <i>Electrical fast transient/burst</i>  IEC 61000-4-4	$\pm 2\text{kV}$ per le linee di alimentazione di potenza <i>for power supplies lines</i> $\pm 1\text{kV}$ per linee input-output / <i>for input-output lines</i>	$\pm 2\text{kV}$ per le linee di alimentazione di potenza <i>for power supplies lines</i>	La qualità della tensione di rete dovrebbe essere quella di un tipico ambiente commerciale o ospedaliero. <i>Mains power quality should be that of a typical commercial or hospital environment.</i>
Sovratensioni overvoltage IEC 61000-4-5	$\pm 1\text{kV}$ linea(e) – linee / <i>Line(s) to line</i> $\pm 2\text{kV}$ linea(e) – terra / <i>Line(s) to earth</i>	$\pm 1\text{kV}$ linea(e) – linee / <i>Line(s) to line</i> $\pm 2\text{kV}$ linea(e) – terra / <i>Line(s) to earth</i>	La qualità della tensione di rete dovrebbe essere quella di un tipico ambiente commerciale o ospedaliero. <i>Mains power quality should be that of a typical commercial or hospital environment.</i>
Buchi di tensione, brevi interruzioni e variazioni di tensione sulle	$<5\% U_T$ (>95% buco in / <i>dip in <math>U_T</math></i> )	$<5\% U_T$ (>95% buco in / <i>dip in <math>U_T</math></i> )	La qualità della tensione di rete dovrebbe essere quella di un tipico ambiente commerciale o ospedaliero. Se l'utilizzatore di

Guida e dichiarazione del costruttore – IMMUNITÀ ELETTROMAGNETICA – PER TUTTI GLI APPARECCHI ED I SISTEMI			
<i>Guidance and manufacturer's declaration – ELECTROMAGNETIC IMMUNITY – FOR ALL EQUIPMENT AND SYSTEMS</i>			
<p>Il POWERSONIC è previsto per funzionare nell'ambiente elettromagnetico sotto specificato. Il cliente o l'utilizzatore di POWERSONIC deve garantire che esso venga usato in tale ambiente.</p> <p><i>The POWERSONIC is intended for use in the electromagnetic environment specified below. The customer or the user of the device should assure that it is used in such an environment</i></p>			
Prova di immunità <i>Immunity test</i>	Livello di prova <i>Test level</i> IEC 60601	Livello di conformità <i>Compliance level</i>	Ambiente elettromagnetico – Guida <i>Electromagnetic environment - guide</i>
linee di ingresso dell'alimentazione <i>Voltage dips, short interruptions and voltage variations on power supply input lines</i>  IEC 61000-4-11	per / for 0,5 cicli / cycles  40% $U_T$ (60% buco in / dip in $U_T$ ) per / for 5 cicli / cycles  70% $U_T$ (30% buco in / dip in $U_T$ ) per / for 25 cicli / cycles  <5% $U_T$ (>95% buco in / dip in $U_T$ ) per/ for 5s	per / for 0,5 cicli / cycles  40% $U_T$ (60% buco in / dip in $U_T$ ) per / for 5 cicli / cycles  70% $U_T$ (30% buco in / dip in $U_T$ ) per / for 25 cicli / cycles  <5% $U_T$ (>95% buco in / dip in $U_T$ ) per/ for 5s	POWERSONIC richiede un funzionamento continuato anche durante l'interruzione della tensione di rete, si raccomanda di alimentare il POWERSONIC con un gruppo di continuità (UPS) o con batterie. <i>Main power quality should be that of a typical commercial or hospital environment. If the user of POWERSONIC requires continued operation during power mains interruptions, it is recommended that MIO_SONIC be powered from an uninterruptible power supply (UPS) or a battery.</i>
Campo magnetico a frequenza di rete (50/60 Hz) <i>Power frequency (50/60 Hz) magnetic field</i>  IEC 61000-4-8	30A/m	30A/m	I campi magnetici a frequenza di rete dovrebbero avere livelli caratteristici di una località tipica in ambiente commerciale o ospedaliero. <i>Power frequency magnetic fields should be at levels characteristic of a typical location in a typical commercial or hospital environment</i>
Nota: $U_T$ è la tensione di rete in c.a. prima dell'applicazione del livello di prova. <i>Note: <math>U_T</math> is the A.C. mains voltage prior to application of the test level.</i>			

Guida e dichiarazione del costruttore – IMMUNITÀ ELETTRONMAGNETICA – PER GLI APPARECCHI ED I SISTEMI CHE NON SONO DI SOSTENTAMENTO DI FUNZIONI VITALI <i>Guidance and manufacturer's declaration – ELECTROMAGNETIC IMMUNITY – FOR EQUIPMENT AND SYSTEMS THAT ARE NOT LIFE-SUPPORTING</i>			
<p>Il POWERSONIC è previsto per funzionare nell'ambiente elettromagnetico sotto specificato. Il cliente o l'utilizzatore del POWERSONIC deve garantire che esso venga usato in tale ambiente.</p> <p><i>The device is intended for use in the electromagnetic environment specified below. The customer or the user of the device should assure that it is used in such an environment.</i></p>			
Prova di immunità <i>Immunity test</i>	Livello di prova <i>Test level</i> IEC 60601	Livello di conformità <i>Conformity level</i>	Ambiente elettromagnetico – Guida <i>Electromagnetic environment - guide</i>
<p>Gli apparecchi di comunicazione a RF portatili e mobili non dovrebbero essere usati vicino a nessuna parte del dispositivo, compresi i cavi, eccetto quando sono rispettate le distanze di separazione raccomandate, calcolate dall'equazione applicabile alla frequenza del trasmettitore.</p> <p><i>Portable and mobile RF communications equipment should not be used near any part of the device, including cables, except when the recommended separation distance is respected, calculated from the equation applicable to the frequency of the transmitter.</i></p>			
Distanza di separazione raccomandata – Recommended separation distance			
RF condotta <i>Conducted RF</i>  IEC 61000-4-6	3V <sub>eff</sub> da 150kHz a 80MHz <i>from 150kHz to 80MHz</i>	3V <sub>eff</sub> da 150kHz a 80MHz <i>from 150kHz to 80MHz</i>	$d = 1,2 \sqrt{P}$ da 150kHz a 80MHz <i>from 150kHz to 80MHz</i>
RF irradiate <i>Radiated RF</i>  IEC 61000-4-3	10V/m da 80MHz a 2,7GHz <i>from 80MHz to 2,7GHz</i>	10V/m da 80MHz a 2,7GHz <i>from 80MHz to 2,7GHz</i>	$d = 1,2 \sqrt{P}$ da 80MHz a 800MHz <i>from 80MHz to 800MHz</i> $d = 2,3 \sqrt{P}$ da 800MHz a 2,7GHz <i>from 800MHz to 2,7GHz</i>
<p>ove P è la potenza massima nominale d'uscita del trasmettitore in Watt (W) secondo il costruttore del trasmettitore e d è la distanza di separazione raccomandata in metri (m). Le intensità di campo dei trasmettitori a RF fissi, come determinato da un'indagine elettromagnetica<sup>a</sup> del sito potrebbe essere minore del livello di conformità in ciascun intervallo di frequenza<sup>b</sup> Si può verificare interferenza in prossimità di apparecchi contrassegnati dal seguente simbolo:</p> <p><i>Where P is the maximum output power rating of the transmitter in watts (W) according to the transmitter manufacturer and d is the recommended separation distance in metres (m).</i></p> <p><i>Field strengths from fixed RF transmitters, as determined by an electromagnetic site survey<sup>a</sup>, should be less than the compliance level in each frequency range<sup>b</sup>. Interference may occur in the vicinity of equipment marked with the symbol above:</i></p>			
<p>Note:</p> <p>(1) A 80MHz e 800MHz; si applica l'intervallo di frequenza più alto.</p>			



**Guida e dichiarazione del costruttore – IMMUNITÀ ELETTROMAGNETICA – PER GLI APPARECCHI ED I SISTEMI CHE NON SONO DI SOSTENTAMENTO DI FUNZIONI VITALI**  
**Guidance and manufacturer's declaration – ELECTROMAGNETIC IMMUNITY – FOR EQUIPMENT AND SYSTEMS THAT ARE NOT LIFE-SUPPORTING**

Il POWERSONIC è previsto per funzionare nell'ambiente elettromagnetico sotto specificato. Il cliente o l'utilizzatore del POWERSONIC deve garantire che esso venga usato in tale ambiente.

*The device is intended for use in the electromagnetic environment specified below. The customer or the user of the device should assure that it is used in such an environment.*

*At 80 MHz and 800 MHz, the higher frequency range applies.*

(2) Queste linee guida potrebbero non applicarsi in tutte le situazioni. La propagazione elettromagnetica è influenzata dall'assorbimento e dalla riflessione di strutture, oggetti e persone.

*Electromagnetic propagation is affected by absorption and reflection from structures, objects and people.*

a) Le intensità di campo per trasmettitori fissi come le stazioni base per radiotelefoni (cellulari e cordless) e radiomobili terrestri, apparecchi di radioamatori, trasmettitori radio in AM e FM e trasmettitori TV non possono essere previste teoricamente e con precisione. Per valutare un ambiente elettromagnetico causato da trasmettitori RF fissi, si dovrebbe considerare un'indagine elettromagnetica del sito. Se l'intensità di campo misurata nel luogo in cui si usa un POWERSONIC, supera il livello di conformità applicabile di cui sopra, si dovrebbe porre sotto osservazione il funzionamento normale del POWERSONIC. Se si notano prestazioni anormali, possono essere necessarie misure aggiuntive come un diverso orientamento o posizione del POWERSONIC.

*Field strengths from fixed RF transmitters, such as base stations for radio (cellular/cordless) telephones and land mobile radios, amateur radio, AM and FM radio broadcast and TV broadcast cannot be predicted theoretically with accuracy.*

*To assess the electromagnetic environment due to fixed RF transmitters, an electromagnetic site survey should be considered. If the measured field strength in the location in which POWERSONIC is used exceeds the applicable RF compliance level above, POWERSONIC should be observed to verify normal operation. If abnormal performance is observed, additional measures may be necessary, such as re-orienting or relocating POWERSONIC.*

b) L'intensità di campo nell'intervallo di frequenza da 150kHz a 80MHz dovrebbe essere minore di 3V/m.

*Over the frequency range 150kHz to 80MHz, field strengths should be less than 3V/m.*

**Distanze di separazione raccomandate tra apparecchi di radiocomunicazione portatili e mobili per POWERSONIC che non sono di sostentamento delle funzioni vitali**  
**Recommended separation distances between portable and mobile RF communications equipment for POWERSONIC that are not life-supporting**

Il POWERSONIC è previsto per funzionare in un ambiente elettromagnetico in cui sono sotto controllo i disturbi irradiati RF. Il cliente o l'operatore del POWERSONIC possono contribuire a prevenire interferenze elettromagnetiche assicurando una distanza minima fra gli apparecchi di comunicazione mobili e portatili a RF (trasmettitori) e il POWERSONIC come sotto raccomandato, in relazione alla potenza di uscita massima degli apparecchi di radiocomunicazione.

*POWERSONIC is intended for use in an electromagnetic environment in which radiated RF disturbances are controlled. The customer or the user of POWERSONIC can help prevent electromagnetic interference by maintaining a minimum distance between portable and mobile RF communications equipment (transmitters) and POWERSONIC as recommended below, according to the maximum output power of the communications equipment.*

Potenza di uscita massima del trasmettitore specificata (W) <i>Rated maximum output power of transmitter (W)</i>	Distanza di separazione alla frequenza del trasmettitore (m) <i>Separation distance according to the frequency of the transmitter (m)</i>		
	<i><math>d = 1,2 \sqrt{P}</math> da 150kHz a 80MHz from 150kHz to 80 MHz</i>	<i><math>d = 1,2 \sqrt{P}</math> da 80MHz a 800MHz from 80MHz to 800 MHz</i>	<i><math>d = 2,3 \sqrt{P}</math> da 800MHz a 2,7GHz from 800MHz to 2,7GHz</i>
0.01	0.12	0.12	0.23
0.1	0.38	0.38	0.73
1	1.2	1.2	2.3
10	3.8	3.8	7.3
100	12	12	23

Per i trasmettitori con potenza nominale massima di uscita sopra non riportata, la distanza di separazione raccomandata  $d$  in metri (m) può essere calcolata usando l'equazione applicabile alla frequenza del trasmettitore, dove  $P$  è la potenza massima nominale d'uscita del trasmettitore in watt (W) secondo il fabbricante del trasmettitore.  
*For transmitters rated at a maximum output power not listed above, the recommended separation distance  $d$  in metres (m) can be determined using the equation applicable to the frequency of the transmitter, where  $P$  is the maximum output power rating of the transmitter in watts (W) according to the transmitter manufacturer.*

Note

- (1) A 80MHz e 800MHz, si applica l'intervallo della frequenza più alto.  
*At 80MHz and 800MHz, the separation distance for the higher frequency range applies.*
- (2) Queste linee guida potrebbero non applicarsi in tutte le situazioni. La propagazione elettromagnetica è influenzata dall'assorbimento e dalla riflessione di strutture, oggetti e persone.  
*These guidelines may not apply in all situations. Electromagnetic propagation is affected by absorption and reflection from structures, objects and people.*

# I-TECH

## MEDICAL DIVISION



**I.A.C.E.R. S.r.l.**

Via Enzo Ferrari 2 - 30037, Scorzè (VE) – Italy

Tel.: (+39) 041 540 13 56 | Email: [iacer@iacer.it](mailto:iacer@iacer.it)

[www.itechmedicaldivision.com](http://www.itechmedicaldivision.com)

Share Capital: € 1.000.000 fully paid-up

Tax Code / VAT Number: IT 00185480274

Certified email: [iacer@pec.it](mailto:iacer@pec.it) | SDI: SUBM70N